

Ma

KEY STAGE
2

LEVELS
3–5

Mathematics test

Test B

Calculator allowed

First name _____

Last name _____

School _____

DfE no. _____

2011

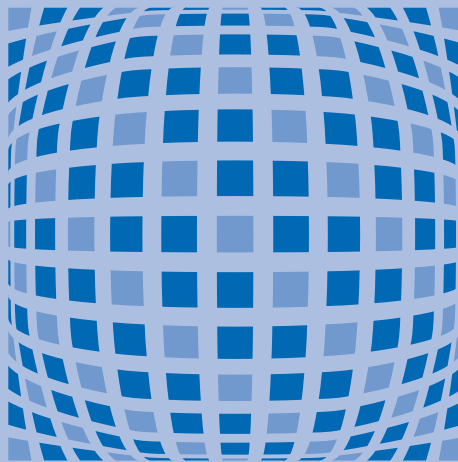

For marker's use only

Page	Marks
5	
7	
9	
11	
13	
15	
17	
19	
21	
23	
25	
TOTAL	

These three children appear in some of the questions in this test.

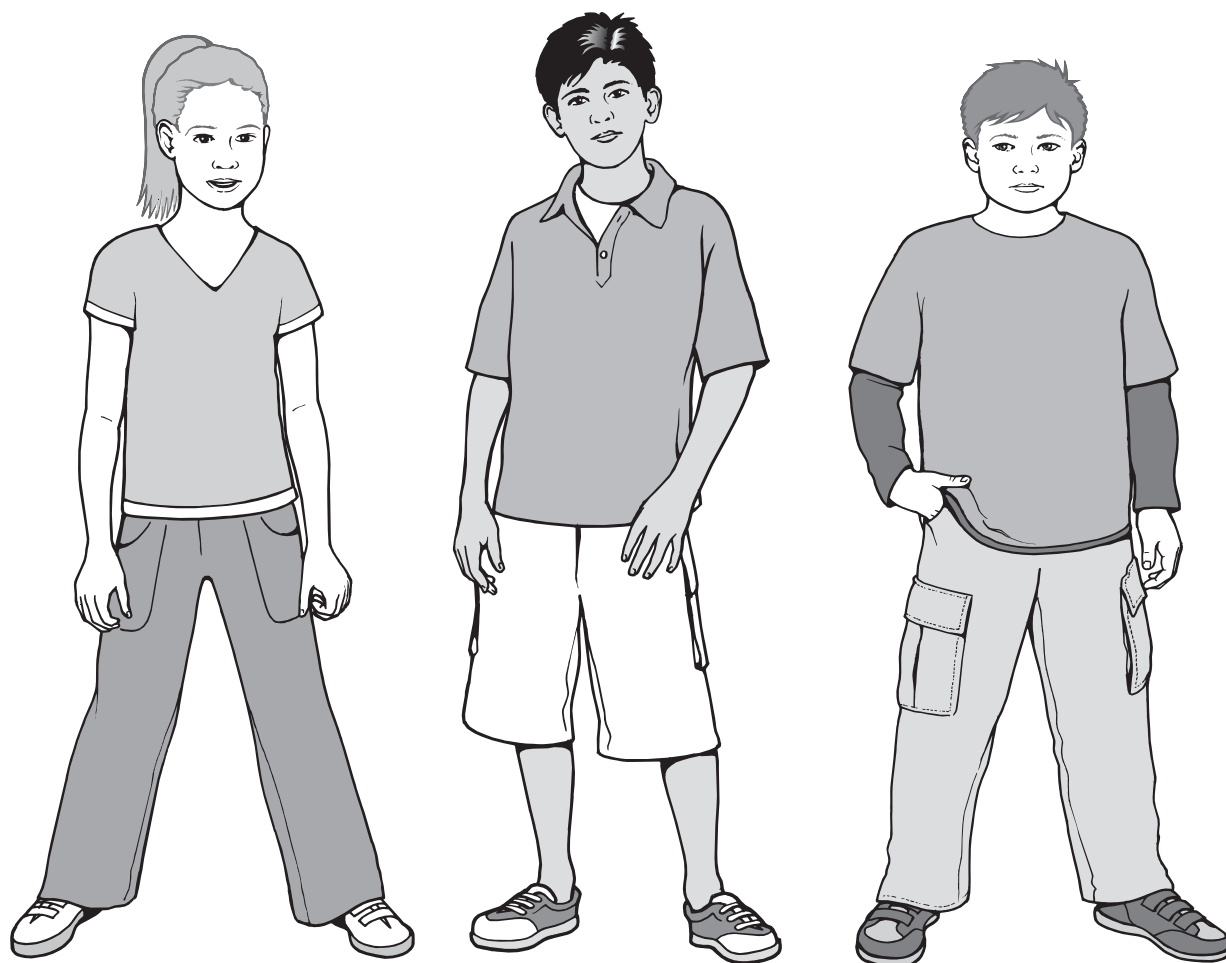

Holly

Dev

Joe

Instructions

You **may** use a calculator to answer any questions in this test.

Work as quickly and as carefully as you can.

You have **45 minutes** for this test.

If you cannot do one of the questions, **go on to the next one**.

You can come back to it later, if you have time.

If you finish before the end, **go back and check your work**.

Follow the instructions for each question carefully.



This shows where you need to put the answer.

If you need to do working out, you can use any space on a page.

Some questions have an answer box like this:



For these questions you may get a mark for showing your method.

1

Circle the number closest to 100



70

120

85

111

909

 ¹
1 mark

2

Here are six number cards.

10

20

30

30

40

50

Use **all** the number cards to complete the two sums below.



$$\square + \square = \square$$

$$\square + \square = \square$$

 ²
1 mark

3

These diagrams are made from regular octagons.

Draw the line of symmetry on each diagram.

Use a ruler.

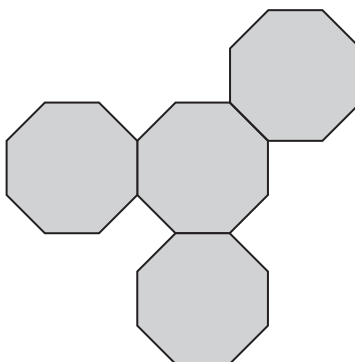
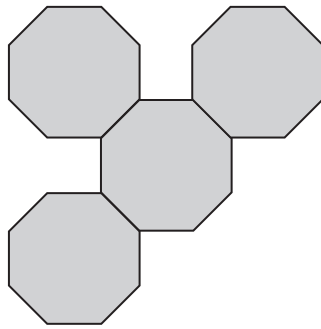
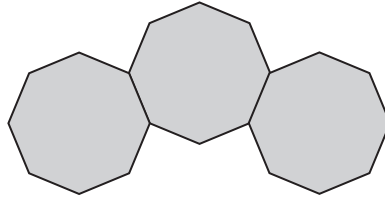

3i

3ii

2 marks

4

For each of these pairs, tick (✓) the calculation that has the **greater** answer.

One has been done for you.

200×4

250×3



34×21

31×24

$444 + 777$

$222 + 888$

$828 - 332$

$939 - 445$

$888 \div 4$

$777 \div 3$

4i

4ii

2 marks

5

Five children grow pumpkins.

This bar chart shows how heavy their pumpkins are.

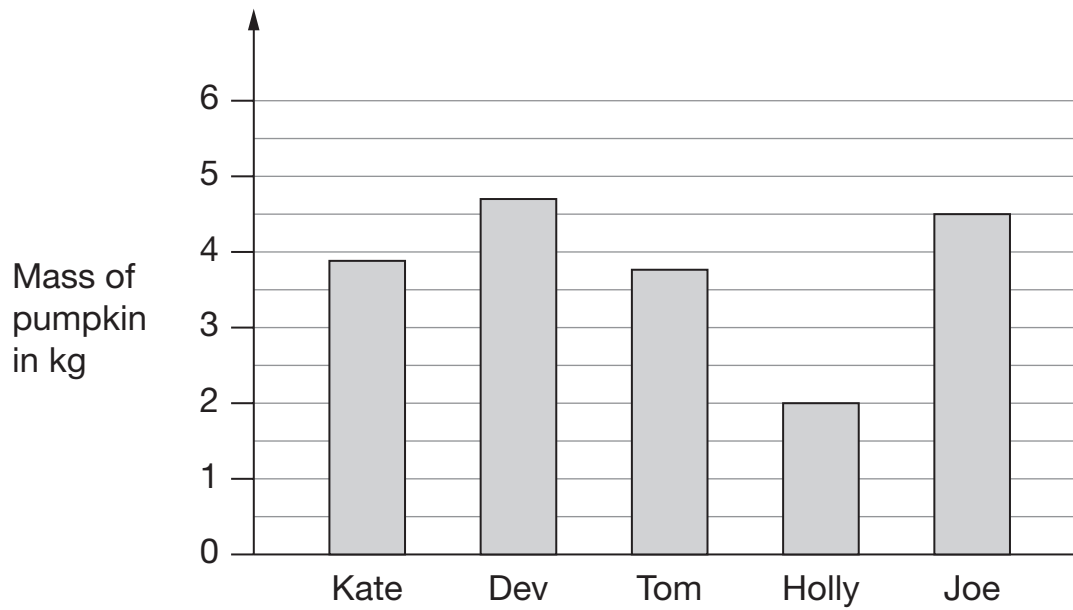

How much heavier is Joe's pumpkin than Holly's?



5a
1 mark

What is the mass of Dev's pumpkin to the nearest kilogram?



5b
1 mark

6

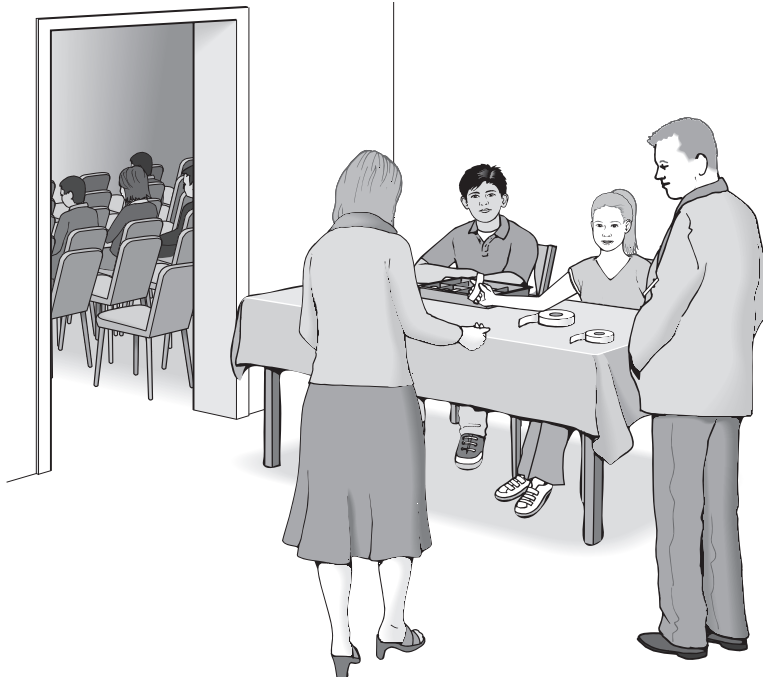

Tickets for a school play cost £2.75 each.

Dev sold 23 tickets.

How much ticket money did Dev collect?



6a
1 mark

Holly collected £77 altogether from selling tickets.

How many tickets did she sell?



6b
1 mark

7

Here are two model boats on a centimetre scale.

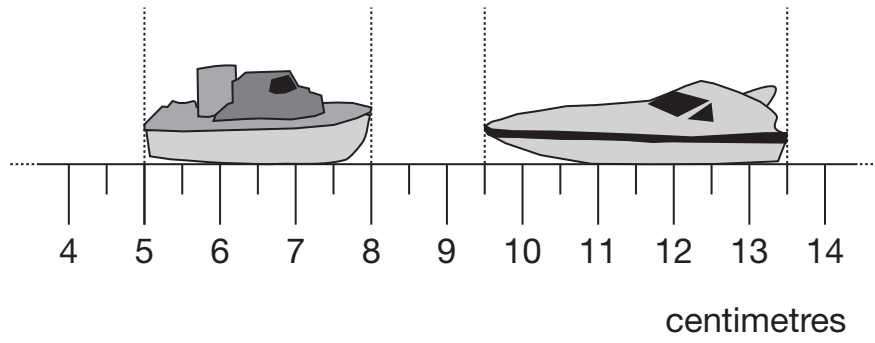

How far apart are the boats?



7a
1 mark

What is the **difference** in the lengths of the two boats?



7b
1 mark

8

Here is part of a number line.

Write in the missing fraction.

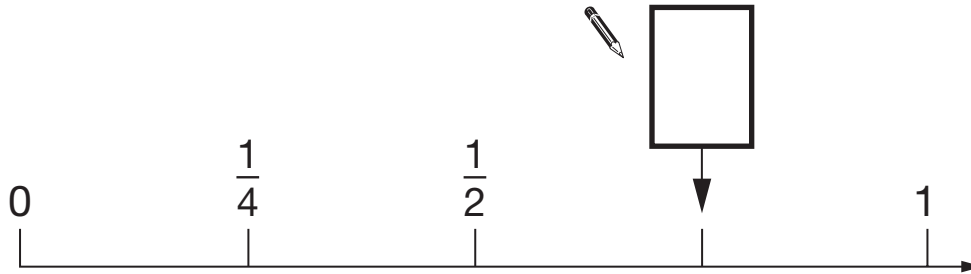

8
1 mark

9

This diagram has four angles marked **A**, **B**, **C** and **D**.

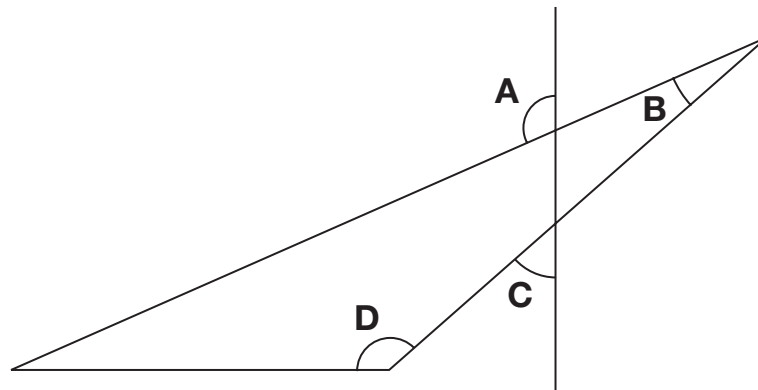

Write the letters of the angles that are **obtuse** angles.



9
1 mark

10

Joe asked the children in his class which flavours of ice-cream they like.

He recorded the results in a Venn diagram.

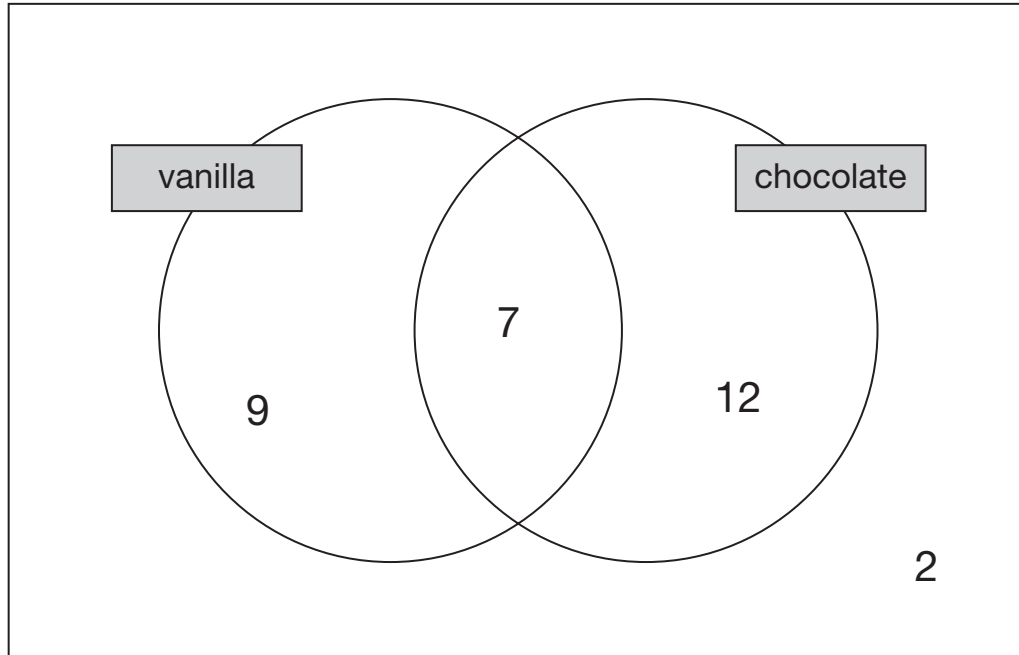

How many children like chocolate ice-cream?



10a
1 mark

How many children **do not** like vanilla ice-cream?



10b
1 mark

11

This diagram shows a shaded rectangle surrounded by squares.

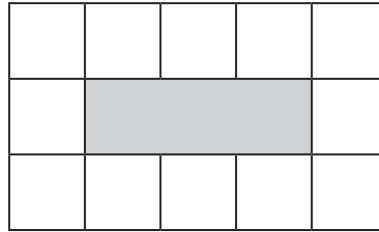

What fraction of the diagram is shaded?

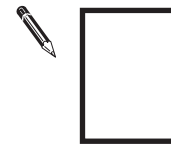

11
1 mark

12

Joe goes skating every Saturday.

He went skating on Saturday January 1st.

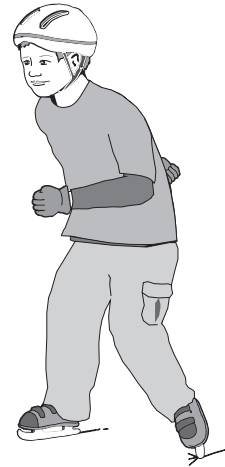

Altogether, how many times did Joe go skating in January?



12
1 mark

13

Dev has a bag of 50p coins and Holly has a bag of 20p coins.



Dev's bag



Holly's bag

Both bags have the same amount of money in.

There are **thirty** 50p coins in Dev's bag.

How many 20p coins are there in Holly's bag?

Show your method

20p coins

13i

13ii

2 marks

14

Here are five shapes made from equilateral triangles.

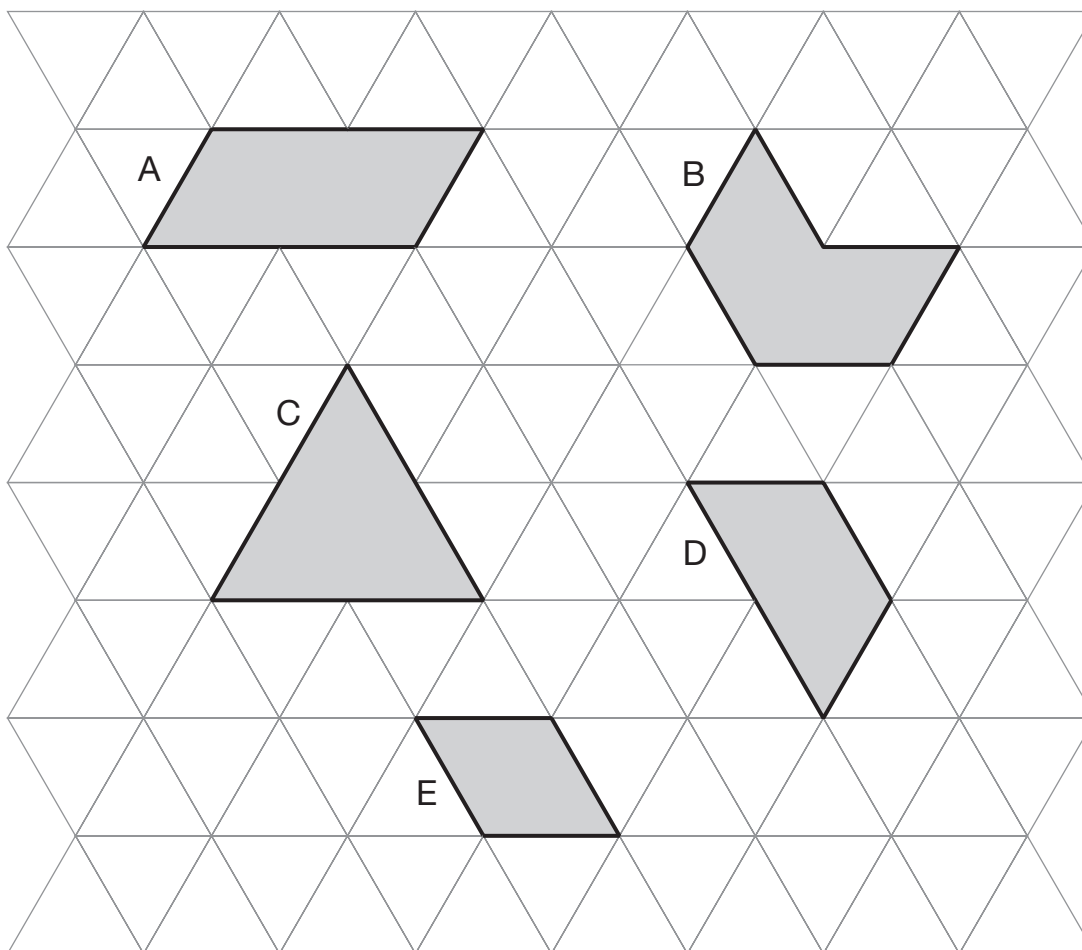

Write the letter of the shape that is a **rhombus**.



14a

1 mark

Write the letter of the shape that has only **one** pair of parallel sides.



14b

1 mark

15

The numbers in this sequence increase by 3 each time.

3 6 9 12 ...

The numbers in this sequence increase by 5 each time.

5 10 15 20 ...

Both sequences continue.

Write a number **greater than 100** which will be in **both** sequences.

Show
your
method



15i

15ii

2 marks

16

Here are four masses.

2 kilograms

1 tonne

800 grams

$\frac{1}{2}$ kilogram

Write the masses in order, starting with the lightest.



--

--

--

--

lightest

16
1 mark

17

Two 2-digit numbers multiply to make 176

Write the two missing numbers.



--	--

×

--	--

= 176

17
1 mark

18

Dev says,

*'When you halve any number that ends in 8
the answer always ends in 4.'*



Is he correct?
Circle **Yes** or **No**.



Yes / No

Explain how you know.



18

1 mark

19

Joe has some triangular tiles and some quarter-circle tiles.

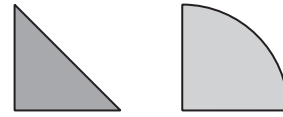

He uses 2 triangles and 7 quarter-circles to make this 'flying bird' design.

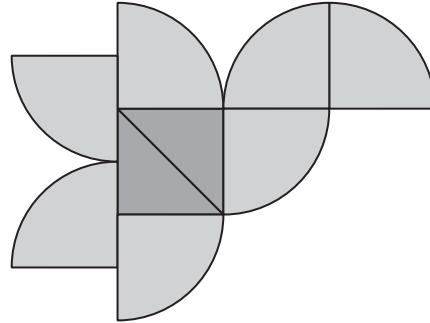

Joe makes some more of these 'flying bird' designs.

He uses 56 quarter-circles.

How many **triangles** does he use?

Show
your
method

A large rectangular box for showing the method, with a pencil icon at the top left and a smaller rectangular box at the bottom right.

19i

19ii

2 marks

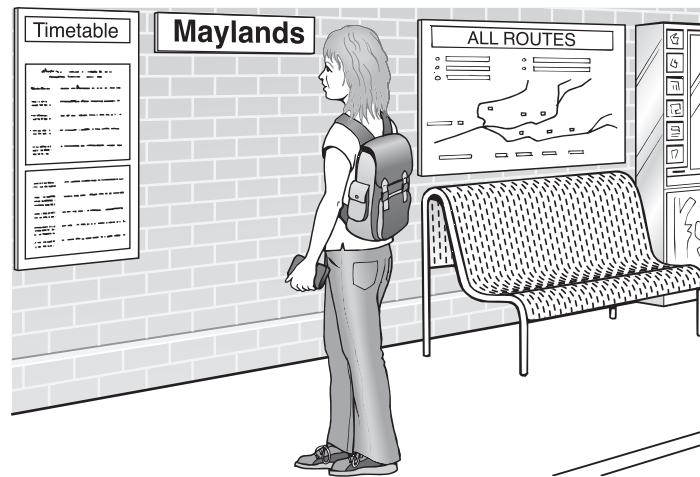

Here is part of the morning train timetable from Perth to Midland in Australia.

Perth	07:11	07:20	07:27	07:35	07:43	07:55
Maylands	–	07:28	07:33	07:43	07:49	08:03
Ashfield	–	–	07:38	–	07:54	–
Success Hill	07:25	–	07:41	–	07:57	–
Midland	07:32	07:41	07:48	07:56	08:05	08:16

What time is the first train from Maylands that stops at Success Hill?



Maylands

20a

1 mark

Mr Evans is in Perth and wants to be in Midland by 08:00

What is the time of the **latest** train he can take from Perth?



Perth

20b

1 mark

21

A bag contains 50 green counters and 40 white counters.

The green counters are numbered 1 to 50

The white counters are numbered 1 to 40

Holly picks one counter without looking.

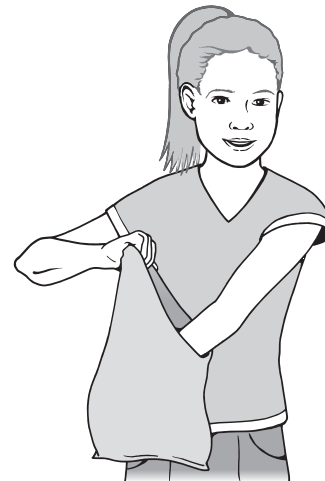

Holly says,

'A counter with the number 35 on it is more likely to be picked than a counter with the number 45 on it'.

Is Holly correct?
Circle **Yes** or **No**.

 Yes / No

Explain how you know.



21

1 mark

22

Here is part of a number line.

It is divided into equal sections.

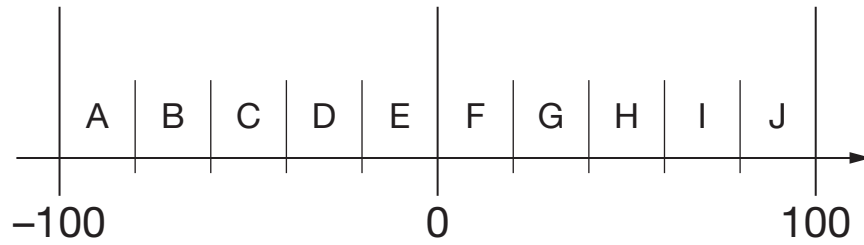

Write the letter of the section where each of these numbers belongs.

The number 99 has been done for you.

number	section
99	J
29	
-83	
-15	
44	

22i

22ii

2 marks

23

Here is a square grid.

Two sides of a kite are drawn on the grid.

Complete the kite by drawing the two missing sides.

Use a ruler.

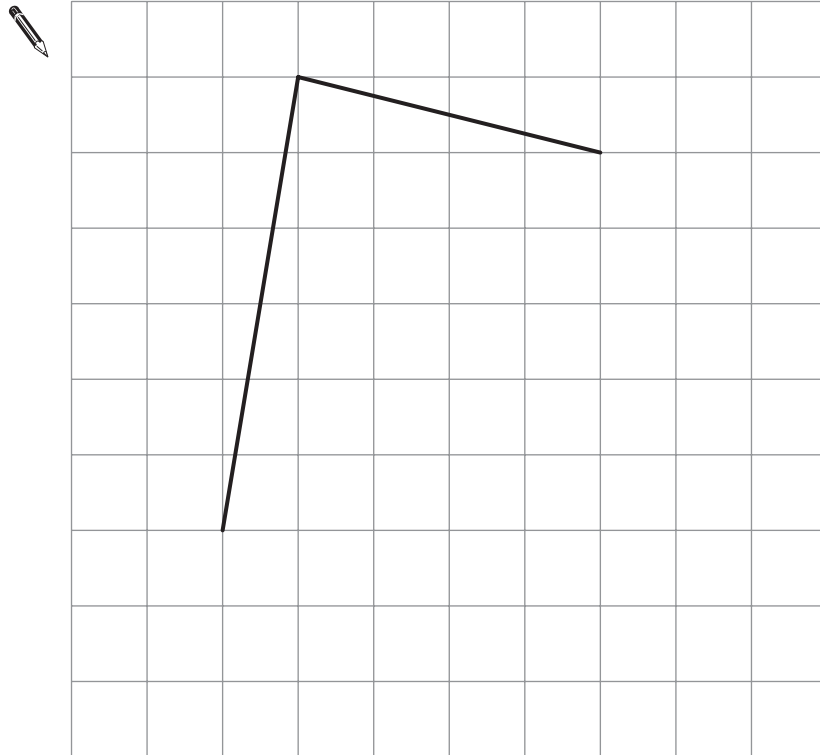

23

1 mark

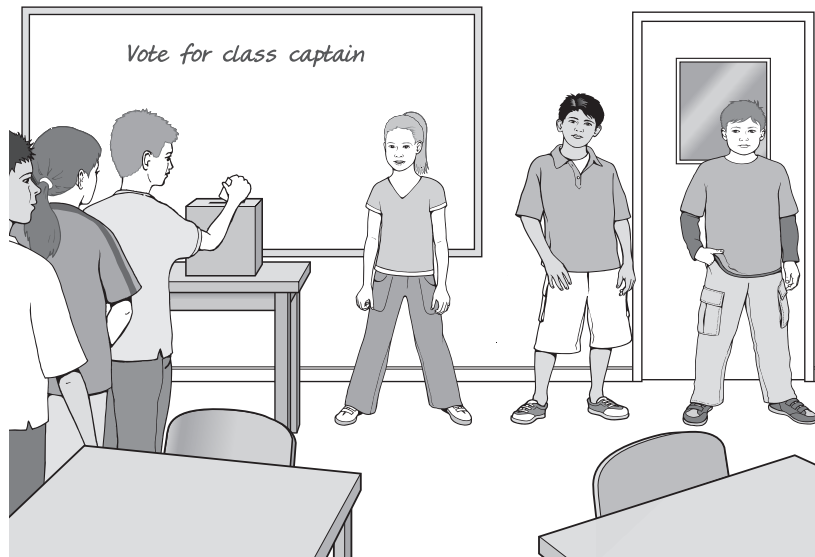

All the children in Class 6 vote to pick a class captain.

The choice is Holly or Dev or Joe.

	Vote once ✕
Holly	<input type="checkbox"/>
Dev	<input type="checkbox"/>
Joe	<input type="checkbox"/>

Dev gets 10% of the votes.

Joe gets twice as many votes as Holly.

What percentage of the votes does the winner get?



 %

24

1 mark

25

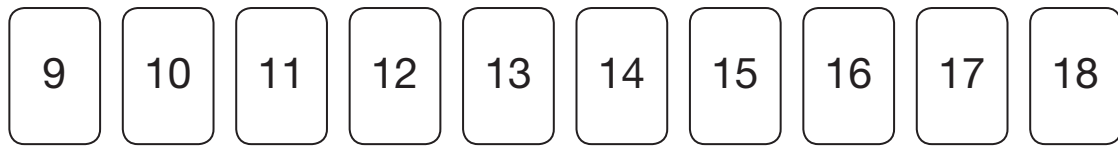
Here are some number cards.



Joe picks two **even** numbers.

Dev picks two **odd** numbers.

Joe gives one of his cards to Dev.

Dev gives one of his cards to Joe.

Joe says,

'Now my cards are both square numbers'.

Dev says,

'Now my cards are both multiples of 5'.

What numbers did they each start with?



Joe started with

and

Dev started with

and

25i

25ii

2 marks

26

A 5p coin has a diameter of 1.8 centimetres.



Holly makes a straight line of 5p coins worth £10



How long is Holly's line?
Give your answer in **metres**.

Show your method

m

26i

26ii

2 marks

End of test



